



GTR-SERIES

2歯面 歯車かみあい試験機

Double Flank Gear Rolling Tester

GTR-4LS 

GTR-SERIES Lineup
Optional equipments

大阪精密機械株式会社
OSAKA SEIMITSU KIKAI CO., LTD.

GTR-SERIES

2歯面 歯車かみあい試験機

Double Flank Gear Rolling Tester

歯車の総合精度を短時間で測定できる「2歯面 歯車かみあい試験機」は、さまざまな産業分野の必需品です。大阪精密機械の2歯面 歯車かみあい試験機「GTR」シリーズは、小モジュール用から小・中型までの歯車の精度測定に対応。総合かみあい誤差、歯当たり、打痕の有無、偏心、バックラッシュなど、多様な種類の測定に威力を発揮します。あらゆる歯車の測定を可能とする特別付属品も用意されており、その精度と使い易さで、国内外のお客様に好評を頂いております。

The double flank gear rolling tester capable of measuring total accuracy in a very short limited time is widely used in various kinds of industries as an indispensable measuring instrument. Osaka Seimitsu Kikai's double flank gear rolling tester, the GTR series, can be applied to the measurement of accuracy of various sizes of gears such as fine pitch gears, small and medium-size gears. It will display its superior capabilities in various kinds of measurements including total composite deviation, tooth bearing, nick, runout, and backlash. The optional equipments are also provided for measuring every kind of gear. Its accuracy and operability have been enjoying a good reputation among many users all over the world.

GTR-4LS NEW

リニアスケール仕様によって より高精度なデータ解析を実現しました。

The linear scale specification has materialized highly accurate data analysis

主な特徴 Major features

- ★ ISO、JIS、AGMA、DINなどの品質規格に対応した付属等級判定ソフト
 The attached grade judgment software supports various quality standards such as ISO, JIS, AGMA and DIN.
- ★ パソコンへの測定データの保管
 Measurement data can be stored on a PC.
- ★ Windows®に対応（英語対応可）
 The tester supports Windows® (English version is also available).
- ★ 中心間距離の設定をリニアスケールにより実現
 テスティング半径の測定、表示機能を可能にしました。
 The linear scale is capable of setting center distance between two centers. A function for measuring and displaying a testing radius is available.
- ★ 円波形などの多彩な出力フォーム
 Various kinds of output forms such as a circular display, etc., are available.
- ★ さまざまな形状の歯車の測定を可能とする
 特別付属品
 Optional equipments are available so that gears with various kinds of shapes can be measured.



歯車かみあい誤差測定結果

Output data

記録線図表示 Linear graph

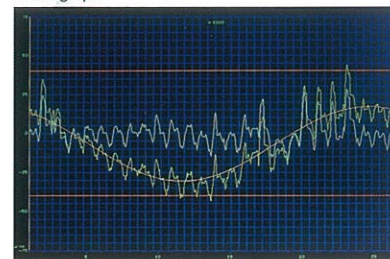

円形線図表示 Circular graph

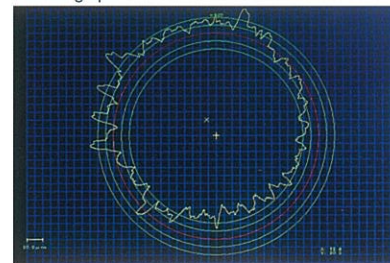

条件例 Item

歯車名称 Gear name	OSK TEST GEAR
コメント Comment	R
ピース番号 Piece number	0
偏心量 Runout	47.0μm
テストングダイヤ Testing diameter	12.354mm
1ピッチかみ合い等級 Tooth-to-tooth composite class	5 JGMAS-S
全かみ合い等級 Total composite class	5 JGMAS-S
1ピッチかみ合い誤差 Tooth-to-tooth composite error	50.2μm
全かみ合い誤差 Total composite error	76.40μm

仕様 Specification

測定最小モジュール Minimum measuring module	m0.2
適用歯車（標準付属品にて） Gear to be measured (with standard equipment)	孔付き平歯車 Flang gear
（特別付属品にて） (with optional equipment)	軸付き平歯車 Gear with shaft カサ歯車・軸交叉歯車 Bevel gear, Cross axis gear ウォームとウォーム歯車 Worm and worm wheel
本体の重量 Weight of basic machine	36kg

解析内容 Analyzing items

1ピッチかみ合い誤差 Tooth-to-tooth composite error
全かみ合い誤差 Total composite error
円イメージ表示 Circular display
偏り成分の除去データ Analog data without eccentricity
入力許容値の合否判定 Judgment, comparing with tolerance
JGMA・AGMA・新JIS・ISO・DINの等級判定 Judgment of accuracy grade of JGMA, AGMA, JIS, ISO and DIN
テストングダイヤの測定 Testing diameter measurement

(4LSをのぞく) Except 4LS

GTR-SERIES Lineup

2歯面 歯車かみあい試験機ラインナップ Double Flank Gear Rolling Testers Lineup

機種 Model Name	中心間距離 Center Distance				
	100	200	300	400	500(mm)
GTR-25		(特25~) 105~250 (Optional Specification 25~)			
GTR-40			(特30~) 110~400 (Optional Specification 30~)		
GTR-60				(特40~) 120~600 (Optional Specification 40~)	
GTR-30		(特38~) 58~300 (Optional Specification 38~)			

2歯面かみあい
Double Flank
Gear Rolling

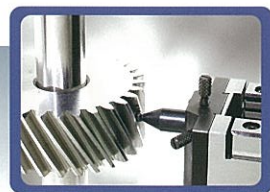

CS-251型測定機構
MODEL: CS-251 Measuring mechanism



データ (GTR-25CS)
data

GTR-25 (特別付属品付)
(with optional equipments)

GTR-25 IN

GTR-25 中心間距離(特25~) 105~250mm Center Distance (Optional Specification 25~)

仕様 Specification

測定項目 Measuring item	2歯面かみあい試験 Double flank rolling test	測定圧 Measuring pressure	-1~0~+2.5kg
適用歯車 Gear to be measured	平・ハスハ歯車 Spur and helical gear (特別付属品にて) カサ歯車 (with optional equipment) Bevel gear ウォームとウォーム歯車、内歯車 Worm and Worm wheel, Internal gear	駆動(主軸モータ駆動) Spindle (Motor drive)	0.5~9r.p.m
中心間距離 Center distance	105~250mm (特別付属品にて) 25~170mm (with optional equipment) 70~215mm	電源 Power	AC100V 50/60Hz 1KVA
		本体の大きさ(L×W×H) Size of basic machine	925×456×472mm
		本体の重量 Weight of basic machine	300kg



GTR-40 中心間距離(特30~) 110~400mm Center Distance (Optional Specification 30~)

仕様 Specification

測定項目 Measuring item	2歯面かみあい試験 Double flank rolling test	測定圧 Measuring pressure	-1~0~+2.5kg
適用歯車 Gear to be measured	平・ハスハ歯車 Spur and helical gear (特別付属品にて) カサ歯車 (with optional equipment) Bevel gear ウォームとウォーム歯車、内歯車 Worm and Worm wheel, Internal gear	駆動(主軸モータ駆動) Spindle (Motor drive)	0.5~9r.p.m
中心間距離 Center distance	110~400mm (特別付属品にて) 30~320mm (with optional equipment) 75~365mm	電源 Power	AC100V 50/60Hz 1KVA
		本体の大きさ(L×W×H) Size of basic machine	1,010×540×460mm
		本体の重量 Weight of basic machine	450kg



GTR-60 中心間距離(特40~) 120~600mm Center Distance (Optional Specification 40~)

仕様 Specification

測定項目 Measuring item	2歯面かみあい試験 Double flank rolling test	測定圧 Measuring pressure	-1~0~+2.5kg
適用歯車 Gear to be measured	平・ハスハ歯車 Spur and helical gear	駆動(主軸モータ駆動) Spindle (Motor drive)	0.4~4r.p.m
中心間距離 Center distance	120~600mm (特別付属品にて) 40~520mm (with optional equipment) 85~565mm	電源 Power	AC100V 50/60Hz 1KVA
		本体の大きさ(L×W×H) Size of basic machine	2,060×918×1,071mm
		本体の重量 Weight of basic machine	2,200kg



GTR-30 中心間距離(特38~) 58~300mm Center Distance (Optional Specification 38~)

仕様 Specification

測定項目 Measuring item	2歯面かみあい試験 Double flank rolling test	測定圧 Measuring pressure	0~2.5kg
適用歯車 Gear to be measured	平・ハスハ歯車 Spur and helical gear	駆動(主軸モータ駆動) Spindle (Motor drive)	6r.p.m
中心間距離 Center distance	58~300mm (標準センターマンドレル使用時に) (with standard center mandrel) (特別センターマンドレル使用時に) (with optional center mandrel)	電源 Power	AC100V 50/60Hz 1KVA
		本体の大きさ(L×W×H) Size of basic machine	830×325×360mm
		本体の重量 Weight of basic machine	約120kg Approx.120kg



AG-230 歯車選別機 M1.0~ 中心間距離 70~230mm Gear selecting machine M1.0~ Center Distance 70~230mm

AG-230型は汎用性を持たせた手置きタイプの歯車選別機です。各センサーを自在に変更できる構造にして、大きさを問わず歯車の選別を可能にしました。
打痕・偏心・サイズの許容値との比較で合格・不合格を簡単に判定でき、マスターギヤの偏心補正も可能です。自動化されていないラインでの歯車最終検査に適しています。
AG-230 is versatile hand operate gear selecting machine. It can process either pinion or wheel, by changing the sensor.
Comparing to the tolerance of nick, runout and gear size, machine can judge the passed or failed gear easily. Also runout correction of master gear is available.



標準付属品

Standard equipments

GTR-4LS

1. 据付台	1	5. パーソナルコンピューター	1
2. モータードライブ装置	1	6. プリンター(インクジェット)	1
3. 試験軸(φ12.7)2本	1	7. パソコン用I/Fボード	1
4. 工具	1	8. ソフトウェア(Windows®日本語又は英語)	1

特別付属品

Optional equipments

軸付平歯車装置 Center support attachment



関係寸法図
Related drawing

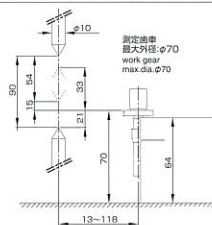

軸付平歯車装置(大型) Center support attachment (Large)



関係寸法図
Related drawing

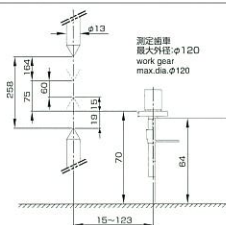

カサ歯車装置 Bevel gear attachment



関係寸法図
Related drawing

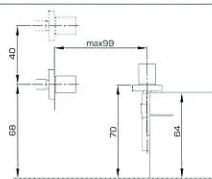

測定原理

Measuring principle

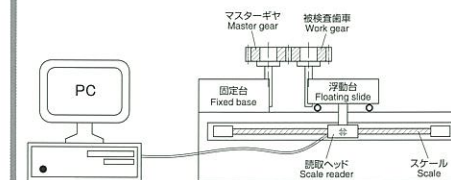

左図のように、測定対象の歯車とマスターギヤをバックラッシュ(隙間)が無くなるように押し付けて回転させると、歯車の各種の誤差により、双方の中心距離が変動します。この変動量をリニアスケールで読み取り、付属品のパソコンで解析して各規格の許容値と比較するのが、GTRシリーズの測定の原理です。主に、国際規格(ISO)、日本工業規格(JIS)、アメリカ歯車工業会規格(AGMA)、ドイツ工業規格(DIN)などの規格に対応しています。

As shown in the left figure, revolve the gear to be measured and master gear by pressing together without backlash (gap), then the center distance of both gears will vary according to the various kinds of deviations of the gear. This variation is read by linear scale and analyzed with the PC, attached as an accessory, and is conducted with tolerance of various kinds of standards. This is the measuring principle of the GTR series. This is compliant with international standards (ISO), Japanese industrial standards (JIS), American Gear Industry Association standards (AGMA), and German institute for Standardization(DIN),etc.

軸交叉歯車装置 Cross shaft gear attachment



関係寸法図
Related drawing

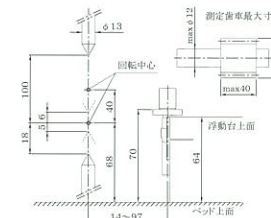

コの字型治具 Jig for gear with shaft



関係寸法図
Related drawing

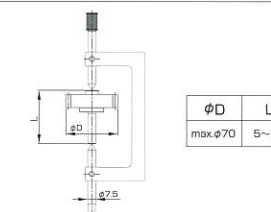

PC装置 PC terminal



従来機GTR-4型にPC装置を記録計(E-010,E-020)の代わりに付属する事により、記録方法を現在のようなプリンター方式に変更することが出来ます。

The recording method can be changed from the recorder (E-010, E-020) to the printer method like the current system by attaching a PC terminal to the older GTR-4 model.

マスターギヤ Master gear



モジュール Module	P.C.D	A内径 Inner diameter	B外径 Outer diameter	C歯巾 Tooth width	歯数 No. of teeth
0.2	39.0	12.7	38.4	12.7	190
0.25	38.0	12.7	38.5	12.7	152
0.3	38.4	12.7	39.0	12.7	128
0.35	39.5	12.7	39.2	12.7	110
0.4	38.4	12.7	39.2	12.7	96
0.45	38.2	12.7	39.1	12.7	85
0.5	38.0	12.7	39.0	12.7	76
0.6	38.4	12.7	39.6	12.7	64
0.7	39.5	12.7	39.9	12.7	55
0.8	38.4	12.7	40.0	12.7	48
0.9	37.8	12.7	39.6	12.7	42
1.0	38.0	12.7	40.0	12.7	38

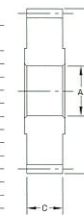

特別付属品 Optional equipments

GTR-SERIES

あらゆる用途に対応できるように、特別付属品を用意しております。
Optional equipments are available to support any kind of use

自動選別カウンタ

Automatic gear selecting counter

2歯面かみあい試験の測定値と、事前に設定した許容値に対するOK/NGの判定の双方を、リアルタイムでデジタル表示します。選別項目は打痕、偏心、サイズの3つです。この装置があれば、歯車の測定と良否の判定が誰にでも可能になります。

This device enables to the digital display of the OK/NG judgment for the measuring value of the double flank gear rolling test against the pre-set tolerance on a real-time basis. Three selecting items are "nick," "runout," and "size." With this device, anyone can measure gears and judge OK or NG.



2重スライドセンター台 (VTS)

Double slide center base (VTS)

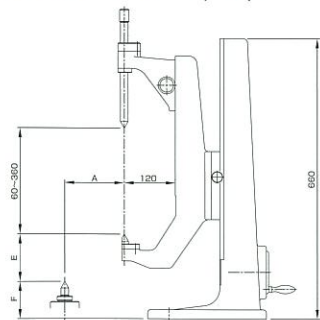

No.		GTR-25	GTR-40
VTS-251 (固定台側) (Fixed side)	A	25~140	25~290
	E	30~200	-10~160
	F	87	126

マスターギヤ

Master gear



(汎用)・圧力角20° or 14.5°・内径φ32 歯巾20
(For standard use)・pressure angle 20° or 14.5°・Inner dia φ32 Tooth width 20

モジュール Module	歯数 No. of teeth	P.C.D.	モジュール Module	歯数 No. of teeth	P.C.D.
1.75	45	78.75	3.0	38	114.0
2.0	40	60.0	3.5	32	112.0
2.25	36	81.0	4.0	28	112.0
2.5	32	80.0	5.0	30	150.0
2.75	42	115.5	6.0	26	156.0

軸付歯車装置 (VD型)

Gear with shaft equipment (VD type)

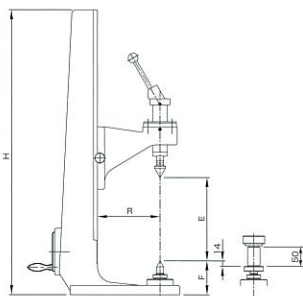

No.	H	R	GTR-25		GTR-40	
			F	E	F	E
VDS-251 (固定台側) (Fixed side)						
VDF-251 (浮動台側) (Floating side)	660	120	87	80~460	126	40~420
VDS-252 (固定台側) (Fixed side)						
VDF-252 (浮動台側) (Floating side)	730	160	87	100~510	126	60~470
VDS-253 (固定台側) (Fixed side)						
VDF-253 (浮動台側) (Floating side)	850	160	87	100~630	126	60~590

測定原理

Measuring principle

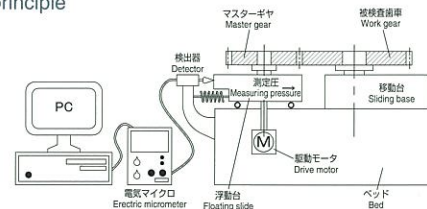

左図のように、測定対象の歯車とマスターギヤをバックラッシュ（隙間）が無くするように押し付けて回転させると、歯車の各種の誤差により、双方の中心距離が変動します。この変動量を作動トランスで読み取り、付属品のパソコンで解析して各規格の許容値と比較するのが、GTRシリーズの測定の原理です。主に、国際規格 (ISO)、日本工業規格 (JIS)、アメリカ歯車工業会規格 (AGMA)、ドイツ工業規格 (DIN) などの規格に対応しています。

As shown in the right figure, revolve the gear to be measured and master gear by pressing together without backlash (gap), then the center distance of both gears will vary according to the various kinds of deviations of the gear. This variation is read by the LVDT (Linear Variable Differential Transformer) and analyzed with the PC, attached as an accessory, for comparison with tolerance values of various kinds of standards. This is the measuring principle of the GTR series. This is compliant with international standards (ISO), Japanese industrial standards (JIS), American Gear Industry Association standards (AGMA) and German institute for Standardization (DIN), etc.

自動偏心装置

Runout equipment

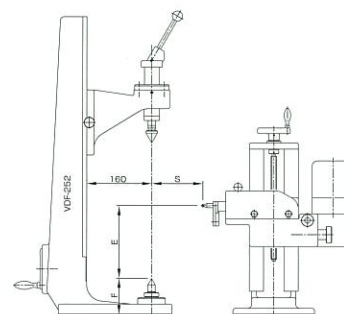

No.		GTR-25	GTR-40
CS-251	E	30~330	0~290
	F	87	126
	S	max.120	max.160

カサ歯車装置

Bevel gear equipment

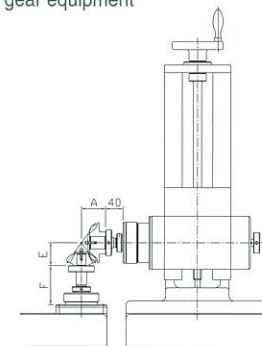

No.		GTR-25	GTR-40
BL-251	A	15~160	15~310
	E	45~220	5~180
	F	33	40

ウォームとウォーム歯車装置

Worm and worm gear equipment

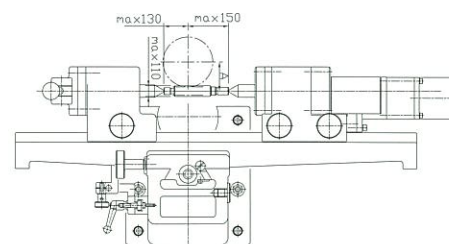

No.		GTR-25	GTR-40
WM-251	A	25~165	25~315

内歯車装置

Internal gear equipment

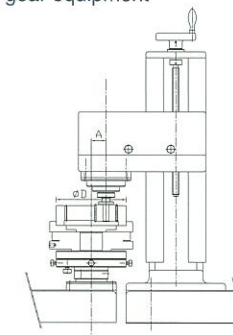

No.		GTR-25	GTR-40
IN-251	A	20~160	20~310
	φD	max200 (A=160)	max500 (A=310)



歯車測定機のことなら私たちにお任せ下さい

Please ask us for solutions to any of your gear measuring needs.

<http://www.osk-corp.co.jp/>

大阪精密機械株式会社

OSAKA SEIMITSU KIKAI CO., LTD.

ISO 9001
BUREAU VERITAS
Certification



大阪精密機械の歯車測定センターGMC (Gear Measuring Center) はISO/IEC 17025:2005 に適合した日本唯一の「歯車」校正機関です。

認定登録番号

Ilac-MRA IA Japan JCSS0190

本社	〒577-0032 大阪府東大阪市御厨6-5-16	TEL.06(6782)0646	FAX.06(6782)0649
東京営業所	〒101-0025 東京都千代田区神田佐久間町3-21-7ポロニア秋葉原201	TEL.03(5825)0031	FAX.03(5825)0032
上海事務所	〒200-336 上海市長寧区婁山关路85号東方国际大厦D座405 A-B	TEL.+86-21-6235-1336	FAX.+66-21-6235-1821
インド駐在事務所	3-51-17, Teachers Colony, Gunrock, Trimulgherry, Secunderabad-5000015, Andhra Pradesh, India	TEL.+91-80080-77755	(駐在員携帯電話)
Head Office	6-5-16 Mikuriya, Higashi-Osaka City, Osaka 577-0032, Japan	TEL.+81-6-6782-0646	FAX.+81-6-6782-0649
Tokyo Sales Office	Polonia Akihabara 201, 3-21-7, Kandasakuma-cho, Chiyoda-ku, Tokyo 101-0025 Japan	TEL.+81-3-5825-0031	FAX.+81-3-5825-0032
Shanghai Sales Office	D-405A-B Room, Oriental International Plaza, 85 Lou Shan Guan Rd, Changning, Shanghai, 200336, China	TEL.+86-21-6235-1336	FAX.+66-21-6235-1821
India Liaison Office	3-51-17, Teachers Colony, Gunrock, Trimulgherry, Secunderabad-5000015, Andhra Pradesh, India	TEL.+91-80080-77755	(Mobile of staff)